

# WHELEN<sup>®</sup>

ENGINEERING COMPANY INC.

51 Winthrop Road  
Chester, Connecticut 06412-0684  
Phone: (860) 526-9504  
Fax: (860) 525-4078  
Internet: [www.whelen.com](http://www.whelen.com)  
Sales e-mail: [autosale@whelen.com](mailto:autosale@whelen.com)  
Canadian Sales e-mail: [autocan@whelen.com](mailto:autocan@whelen.com)  
Customer Service e-mail: [custserv@whelen.com](mailto:custserv@whelen.com)

## Installation/Operating Guide: Model MPC03 Multi-Purpose Controller

### Automotive: Serial Communication

### Safety First

This document provides all the necessary information to allow your Whelen product to be properly and safely installed. Before beginning the installation and/or operation of your new product, the installation technician and operator must read this manual completely. Important information is contained herein that could prevent serious injury or damage.

- **Proper installation of this product requires the installer to have a good understanding of automotive electronics, systems and procedures.**
- **If mounting this product requires drilling holes, the installer MUST be sure that no vehicle components or other vital parts could be damaged by the drilling process. Check both sides of the mounting surface before drilling begins. Also de-burr any holes and remove any metal shards or remnants. Install grommets into all wire passage holes.**
- **If this manual states that this product may be mounted with suction cups, magnets, tape or Velcro®, clean the mounting surface with a 50/50 mix of isopropyl alcohol and water and dry thoroughly.**
- **Do not install this product or route any wires in the deployment area of your air bag. Equipment mounted or located in the air bag deployment area will damage or reduce the effectiveness of the air bag, or become a projectile that could cause serious personal injury or death. Refer to your vehicle owner's manual for the air bag deployment area. The User/Installer assumes full responsibility to determine proper mounting location, based on providing ultimate safety to all passengers inside the vehicle.**
- **For this product to operate at optimum efficiency, a good electrical connection to chassis ground must be made. The recommended procedure requires the product ground wire to be connected directly to the NEGATIVE (-) battery post.**
- **If this product uses a remote device to activate or control this product, make sure that this device is located in an area that allows both the vehicle and the device to be operated safely in any driving condition.**
- **Do not attempt to activate or control this device in a hazardous driving situation.**
- **If this product contains strobe light(s), halogen light(s) or high-intensity LEDs, do not stare directly into these lights. Momentary blindness and/or eye damage could result.**
- **Use only soap and water to clean the outer lens. Use of other chemicals could result in premature lens cracking (crazing) and discoloration. Lenses in this condition have significantly reduced effectiveness and should be replaced immediately. Inspect and operate this product regularly to confirm its proper operation and mounting condition. Do not use a pressure washer to clean this product.**
- **It is recommended that these instructions be stored in a safe place and referred to when performing maintenance and/or reinstallation of this product.**
- **FAILURE TO FOLLOW THESE SAFETY PRECAUTIONS AND INSTRUCTIONS COULD RESULT IN DAMAGE TO THE PRODUCT OR VEHICLE AND/OR SERIOUS INJURY TO YOU AND YOUR PASSENGERS!**

**For warranty information regarding this product, visit [www.whelen.com/warranty](http://www.whelen.com/warranty)**

# Table of Contents

Specifications .....	page 3
Installation	
Control Module .....	page 4
Control Head (Bail Strap Mount) .....	page 4
Control Head (Console Mount).....	page 4
Microphone.....	page 4
Wiring	
System Power .....	page 5
Radio Rebroadcast.....	page 5
Backlighting .....	page 5
Hands-Free Siren .....	page 5
Control Head Cable .....	page 5
Push-Button and Slide Switch Descriptions .....	page 6
Adjustments	
Public Address (PA) Volume Adjustment.....	page 6
Radio Repeat Volume Adjustment .....	page 6

## Illustrations

Bail Strap Mounting .....	page 4
Hands Free Transfer Relay .....	page 5
Control Head Cable Strain Relief.....	page 5
Control Head .....	page 6
Wire Gauge Chart.....	page 7
System Wiring .....	page 8
Wiring a MPC03 into an Existing MPC01 System .....	page 9
MPC03 Wire Identification Information .....	page 10

# Specifications

## General

Input Voltage	12.8 VDC $\pm$ 20%
	Negative Ground Only
Main Input Current	4 Amps Max. / 250mA Typ.
Main Input Fuse	5 Amps
Powered-Down Current	20mA (Typ.)
Operating Temperature	-30°C to +60°C
Storage Temperature	-40°C to +70°C
Humidity	99% (Non-condensing)
Programming Software Compatability	V5.3.0 or later

## Dimensions (Control Module)

Height:	1.25"
Width:	6.75"
Depth:	4.125"

## Dimensions (Control Head)

Height:	3.58"
Width:	6.85"
Depth:	1.32"

# Installation

## Control Module

1. Locate a suitable mounting location. A dry, cool compartment is a good choice.
2. Position the control module on the proposed mounting location. Using an awl or similar tool, scribe the mounting surface where the mounting holes are to be drilled. Make sure that this mounting area allows sufficient ventilation for the control module's air vents and fans.

**Caution:** As mounting the control module will require drilling, it is absolutely necessary to make sure that no other vehicle components could be damaged in the process. Check both sides of the mounting surface before starting. If damage is likely, select a different mounting location.

3. Remove the module from its mounting area, and using a drill bit sized for a #10 sheet metal screw, drill a hole in each of the areas scribed in the previous step.
4. Return the module to its mounting location and using #10 x 3/4" sheet metal screws (provided), secure the module onto its mounting surface. Be sure to install a #10 internal tooth lock washer (included) onto each mounting screw before mounting the unit. **IMPORTANT:** The amp/relay module case must be either mounted on or grounded to the vehicle chassis.

## Control Head

The MPC03 control head features 18 push-buttons with active illumination, a 4-position slide switch (off, 1, 2 & 3) and a Traffic Advisor™ display that enables the operator to view a representation of the pattern being displayed. There are two basic mounting brackets for the MPC03 control head. One allows the control head to be mounted into your vehicle's console (if so equipped). The other allows the control head to be mounted directly onto the dash or other surface through the use of a bail-strap mounting bracket. **Regardless of the style selected, be sure to observe the air bag warning on the cover of this manual.**

## Bail Strap Mount

1. Position the bail strap in the selected mounting location. Using an awl or other suitable tool, scribe the surface where the mounting holes are to be drilled.

**Caution:** As mounting the control head will require drilling, it is absolutely necessary to make sure that no other vehicle components could be damaged in the process. Check both sides of the mounting surface before starting. If damage is likely, select a different mounting location.

2. Drill the mounting holes in the areas scribed in step 1. The size of the drill bit should be determined by the size of the mounting hardware (#10 sheet metal screw) and thickness of the mounting surface.
3. Using hardware provided (#10 x 3/4" sheet metal screw & #10 internal tooth lockwasher, secure the bail strap to the mounting location.

**Note:** There are 3 sets of holes on the bail strap for positioning the control head at 3 different heights.

4. With the bail strap in place, insert the #10 x 3/8" hex head bolt into the assembly hole from the inner side of the bail strap as shown.

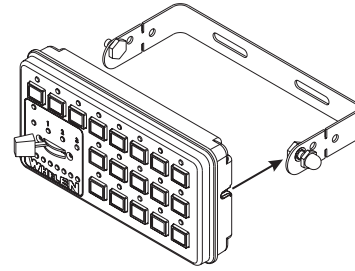

5. Place the #10 internal-tooth lock washer and the acorn nut on the protruding bolt on the outer side of the bail strap. Loosely secure the acorn nut to the hex head bolt.

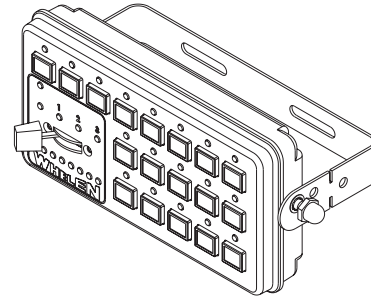

Now slide the control head onto the bolt heads. Once it is in the position that the customer has chosen, and the control head has fully engaged the bolt heads, tighten the acorn nuts until the unit is firmly secured.

A third pair of mounting holes are provided that will enable the control head to be located much closer to the bail strap than the other pairs allow. If this closer location is used, the tips of the bail bracket may be broken off at the notches shown.

## Havis Console Mount

The Havis Console Mounting Kit includes all the necessary hardware needed to secure the control head to the mounting bracket for installation on a Havis Console. The control head mounts onto the console mount bracket the same way the control head mounts onto the bail bracket as outlined previously except for the addition of a flat washer that must be inserted between the control head and the bracket. Please refer to the manual included with your console for specific information on securing the control head/mounting bracket assembly onto the console.

For installation into consoles by other manufacturers, a control head bracket designed for your console must be obtained from the console manufacturer.

## Microphone

A 1/4" port is provided on the left-side of the control module for installation of the microphone. If the optional 20' extension cord is used, install this cord as outlined above. Install the mic plug bracket (included with kit) in the desired area using #8 x 1/2" hardware (included). Route the cord to the plug bracket, install the cable end thru the bracket hole and fasten using the hex nut provided. Secure the cord to the bracket using the cable clamp, #8 x 3/8" machine screw and lock washer.

## Wiring

**WARNING!** All customer supplied wires that connect to the positive terminal of the battery must be sized to supply at least 125% of the maximum operating current and **FUSED** at the battery to carry that load. **DO NOT USE CIRCUIT BREAKERS WITH THIS PRODUCT!** See wire chart on page 7.

NOTE: Item numbers reference the illustration at the bottom of the page.

### Control Head

Route the control head cable (provided) from the control module to the designated mounting location. Plug this cable securely into the rear of the control head. Be sure to route the cable through either of the two recessed pathways (shown here). This will prevent the cable from being accidentally disconnected or pinched by the control head.

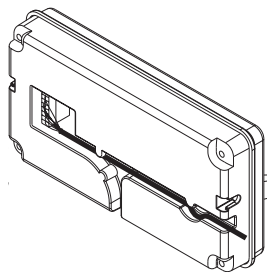

### Radio Rebroadcast (Items 9 & 18)

Two (2) BLU wires are used to connect your two-way radio's external speaker for radio rebroadcast. This is an optional connection and will not effect the other operations.

**Note:** Radio rebroadcast will NOT work with amplified remote speakers! If your remote speaker is amplified (i.e.: contains a power amp circuit in the speaker assembly), do not enable the radio rebroadcast feature.

1. Locate the two wires that connect the external speaker to the two-way radio, cut one of them and splice one of the BLU wires into this circuit.
2. Cut the remaining speaker wire and splice the remaining BLU wire into this circuit.

### Backlighting (Item 2)

1. Route the YEL wire (included) from the control module to the vehicle's marker light circuit.
2. Splice this wire into this circuit to enable the control head backlighting to be active whenever the vehicle's marker light is active.

### Aux. Inputs (Items 12 & 13)

Typical Input connections: K-9 Temperature Sensor, Burglar Alarm, etc..

Aux. Input #1	WHT/BRN (Item 12)	Ground Activated
Aux. Input #2	WHT/RED (Item 13)	Ground Activated

### Aux. Outputs (Items 3, 4, 7 & 8)

Auxiliary outputs #1 and #2 are **Ground Switched**, low current outlets (250mA Max each). Auxiliary outputs #5 and #6 are **Positive Switched**, low current outlets (250mA Max each). Please note that when #1 is active, #5 is also active. When #2 is active, #6 is also active.

Typical Output connections: Gun Lock, Trunk Release, etc.

Aux. Output #1	BRN (Item 8)	Provides Switch Relay (Ground)
Aux. Output #5	GRN/BLK (Item 4)	Provides Switch Relay (Pos)
Aux. Output #2	RED/WHT (Item 7)	Provides Switch Relay (Ground)
Aux. Output #6	BLU/BLK (Item 3)	Provides Switch Relay (Pos)

The main connector is pre-wired to accommodate Outputs #1 & #2 (ground switching). If positive switching is required, two additional wires (included) must be inserted into the main connector. Locate the appropriately colored wires and insert the terminated ends into their respective locations in the connector as shown in the "Control Module Input/Output Identification" section at the bottom of this page. An audible click will indicate when the wires have been fully inserted.

### Hands-Free Siren (Items 6 & 14) (Optional)

1. Using a customer supplied relay capable of handling the current of your vehicle horn, connect as shown below.

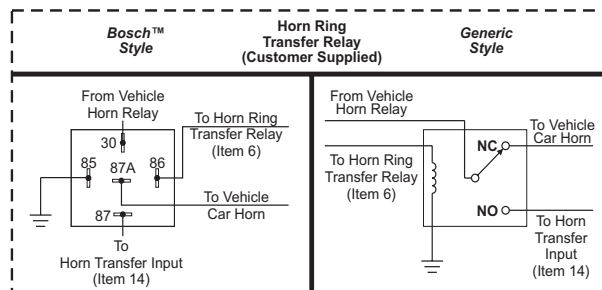

### System Power (Items 1 & 10)

1. Using appropriately sized wire (see wire gauge chart), extend the RED & BLK wires from the Multi-purpose connector to the vehicle battery.
2. Route the BLK wire from the control module to the vehicle's chassis ground typically adjacent to the battery.
3. Route the RED wire from the control module to the vehicle battery.
4. **After all wiring connections have been made, connect the RED wire to the POSITIVE (+) battery terminal. Fuse this wire @ 5 Amps.**

## Control Module Input/Output Identification

- |                                      |  |
|--------------------------------------|--|
| 1. PIN 1 - Power (RED)               | 10. PIN 10 - Ground (BLK)                  |
| 2. PIN 2 - Back Light (YEL)          | 11. PIN 11 - Not Used                      |
| 3. PIN 3 - AUX. Out #6 (BLU/BLK)*    | 12. PIN 12 - AUX. Input #1 (WHT/BRN)       |
| 4. PIN 4 - AUX. Out #5 (GRN/BLK)*    | 13. PIN 13 - AUX. Input #2 (WHT/RED)       |
| 5. PIN 5 - Not Used                  | 14. PIN 14 - Horn Transfer Input (WHT/ORN) |
| 6. PIN 6 - Horn Transfer Relay (ORN) | 15. PIN 15 - Not Used                      |
| 7. PIN 7 - AUX. Out #2 (RED/WHT)     | 16. PIN 16 - Not Used                      |
| 8. PIN 8 - AUX. Out #1 (BRN)         | 17. PIN 17 - Not Used                      |
| 9. PIN 9 - Radio Speaker (BLU)       | 18. PIN 18 - Radio Speaker (BLU)           |

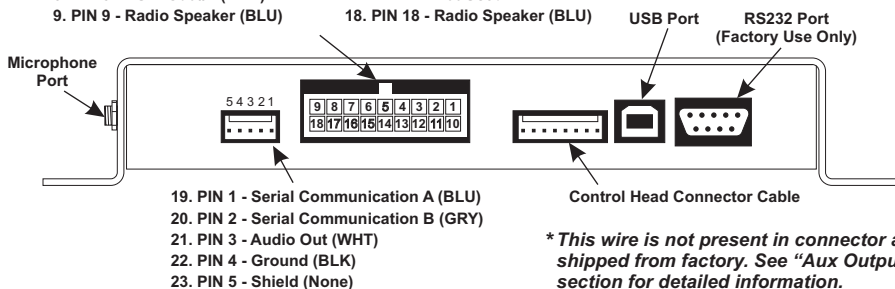

## Diagnostic Monitors

Diagnostic Monitors are provided on the rear of the control module. These troubleshooting aids provide information on the status of several different aspects of the system.

- |                          |              |                  |
|--------------------------|--------------|------------------|
| 1. Network Monitor       | ON=OK        | Flashing=Problem |
| 2. Control Head Monitor  | ON=Connected | OFF=Disconnected |
| 3. Aux Output #1 Monitor | ON=ON        | OFF=OFF          |
| 4. Aux Output #2 Monitor | ON=ON        | OFF=OFF          |
| 5. Horn Relay Monitor    | ON=Active    | OFF=Inactive     |
| 6. Not Used              | ----         |                  |
| 7. Aux Output #5 Monitor | ON=ON        | OFF=OFF          |
| 8. Aux Output #6 Monitor | ON=ON        | OFF=OFF          |

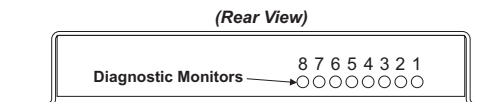

## Volume Adjustment

Locate the VOL. UP and VOL. DOWN control buttons on the control head. With the system on, activate the PTT (Push To Talk) feature on the optional microphone. Press and release these buttons to adjust the volume one increment. Continue to press and release the appropriate volume control button until a satisfactory PA volume level is achieved using a normal speaking voice. Until changed, this is now the default level.

## Radio Repeat Volume Adjustment

The MPC03 allows the user to control Radio Repeat volume from the control head. If this is desired, set the volume control on the vehicle's two-way radio to the normal listening level. Activate the system and press the radio button (RAD) on the control head. As incoming transmissions are received, use the VOL. UP and VOL. DOWN buttons to adjust the radio repeat output levels. Until changed, this is now the default level.

## Control Module Fuse

For ease of access, the control module fuse (5 Amp) is accessible from the top of the case.

## Push-Button and Slide Switch Descriptions

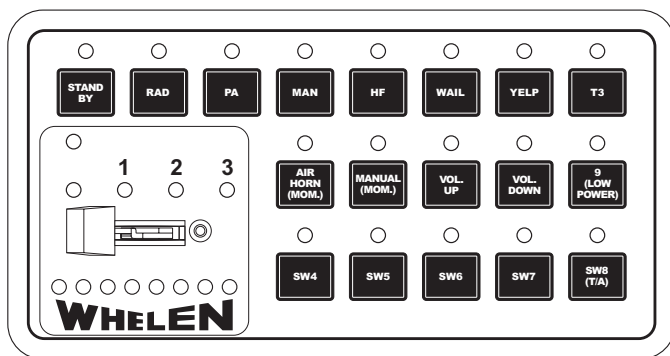

*Labels shown for reference only. Do not install labels until all functions have been assigned and wired.*

**Stand-by (STBY)** - This button clears all siren operations and can be programmed to, upon activation, place the system into either P/A, MAN or HF mode

**NOTE:** The system can be powered down by pressing and holding this button for 3 seconds. If system power is not derived from an ignition-controlled source, this procedure can be used to power down the system.

**Radio Repeat (RAD)** - When this button is pushed, any signal that is received by the vehicle's two-way radio will be simultaneously broadcast over the vehicle's loudspeaker (the two-way radio must be connected to the control module). This function overrides any other siren functions.

**Public Address (PA)** - This is a Stand-by mode. When this button is pressed, public address functions are operational. Messages may be broadcast over the vehicle's loudspeaker when the microphone (connected to the microphone port) is in use. The volume level of PA transmissions is controlled by the volume buttons (see "Volume Adjustments"). If the Momentary Siren button is pressed, a "ramp-up" siren tone will be generated by your vehicle's loudspeaker. This tone is generated until the Momentary Siren button is released. The tone then changes to a "ramp-down." The Air Horn tone may be generated by pressing the vehicle's steering wheel horn button (if the vehicle's horn has been wired to the Serial Communication Network).

**MAN (Manual Mode)** - This is a Stand-by mode. When Manual Mode is active, pressing the Momentary Siren button generates a tone that rises in pitch to a preset level. This tone is generated for as long as the Momentary Siren button is pressed. The same tone may be generated by pressing the vehicle's steering wheel horn button (if the vehicle's horn has

been wired to a horn ring transfer relay). Please note that the microphone will override the siren function.

**Hands-Free (HF)** - When Hands-Free mode is active, the siren function of the network are placed in a Stand-By state. Siren tones are activated by a single tap on the Momentary Siren button or a single tap on the vehicle's steering wheel horn button (if the vehicle's horn has been wired to a horn ring transfer relay). This enables the vehicle operator to control siren functions without having to remove their hands from the steering wheel. The first tap produces a Wail tone (a steady, rise and fall sound). A second tap produces a Yelp tone (a fast, rise and fall tone). A third tap produces a Piercer™ tone (a very fast, rise and fall tone). The next tap returns the siren to a Wail tone and the cycle repeats itself. Two quick, successive taps will stop the siren.

**Wail** - When the WAIL button is pressed, a steady, rise and fall tone is produced. Pressing the Momentary Siren button or the vehicle's steering wheel horn button (if the vehicle's horn has been wired to the network), changes the siren tone to a YELP pattern (a fast, rise and fall tone). Pressing the button again causes the siren to return to the WAIL tone. Please note that the microphone will override the siren function. The tone can be silenced by pressing the STAND-BY button. This button is enabled by default. It can be disabled if the function is not required.

**Yelp** - When the YELP button is pressed, a fast, rise and fall tone is produced. Pressing the Momentary Siren button or the vehicle's steering wheel horn button (if the vehicle's horn has been wired to the network), changes the siren tone to a Piercer™ tone. Pressing the button again causes the siren to return to the Yelp tone. Please note that the microphone will override the siren function. The tone can be silenced by pressing the STAND-BY button. This button is enabled by default. It can be disabled if the function is not required.

**Tone 3 (T3)** - When the T3 button is pressed, an extremely fast, rise and fall tone is produced. Pressing the Momentary Siren button or the vehicle's steering wheel horn button (if the vehicle's horn has been wired to the network), changes the siren tone to a simulated Air Horn tone for as long as the button is pressed. Releasing the button causes the siren to return to the Piercer™ tone. Please note that the microphone will override the siren function. The tone can be silenced by pressing the STAND-BY button. This button is enabled by default. It can be disabled if the function is not required.

**Air Horn (AH)** - This button will broadcast the Air Horn tone as long as the button is pressed, overriding other siren tones. This button is enabled by default. It can be disabled if the function is not required.

**Momentary Siren (MOM SIREN)** - The function of this button depends on the currently active tone. Refer to the descriptions for each siren-related button for further information.

**Vol Up / Vol Down** - See "Volume Adjustment"

**9 (Low Power)** - In the default configuration, this button is programmed as the low power operation switch. Pressing once initiates low-intensity light operation. When the low-power mode has been activated, the diagnostic indicator lights up to inform the operator that the low-power operation mode is active. Pressing control 9 a second time, returns the system to normal, full power operation. This is also the SI-TEST™ initiation button. Refer to the SI-TEST section for information.

**SI-TEST™** - SI-TEST is a diagnostic feature of the serial communication network. When SI-TEST is activated, the MPC03 polls each installed network component and confirms it's operating status. To initiate a SI-TEST, press and hold control 9 for at least 3 seconds. As each component is tested, it's diagnostic indicator will turn on if there is no problem detected, or flash if a failure has been detected. If enabled by the factory or a factory authorized representative, a series of 3, separate alarm tones will be heard whenever a failure has been detected. **NOTE:** Installed network speakers are tested by generating an ultra-high frequency through each speaker. Although these tones are inaudible to humans, be

sure that there is nobody within at least 5 feet of the vehicle's speakers when SI-TEST™ is running.

**Diagnostic Indicators** - The LEDs above the Air Horn and Momentary Siren buttons act as diagnostic indicators for Speakers #1 and #2 respectively (if the vehicle is equipped with a second speaker). When a speaker is active, or in use, its indicator will be on. If a problem is detected with a speaker, its indicator will flash, thus alerting the operator to the failed speaker's condition. If enabled by the factory or a factory authorized representative, a series of 3 separate alarm tones will be heard whenever a failure has been detected.

**SW4 thru SW8** - These push-button switches activate specific, pre-programmed functions of the network. These 5 buttons are referred to as switches 4 (furthest button to the left) through 9. Refer to the Slide Switch section for information on the first 3 controls. If you are not sure exactly how each control is configured, the configuration report, included with the MPC03, details the customized functions for each control. Although each control is custom configured, control 8 can be programmed to handle specific functions of the network:

**SW8** is typically designated to control Traffic Advisor™ functions, if the vehicle is equipped with a Traffic Advisor. There are 4 patterns that are pre-programmed by the factory. Although specific patterns can be

configured at the customer's request, the basic, non-custom patterns are described here for example purposes:

- Press Control 8 ..... Sequence to Left
- Press Control 8 a second time..... Sequence to Right
- Press Control 8 a third time ..... Split Pattern
- Press Control 8 a fourth time ..... Flashing Pattern
- To terminate Traffic Advisor operation, press and hold Control 8.

**SLIDE SWITCH** - The slide switch has 4 positions:

**Position #0** (farthest to the left) - This is an OFF position. When the slide switch is in this position, none of the programmed functions of the remaining 3 positions are active.

**Position #1** (one detent to the right of the OFF position) - When the slide switch is in this position, the programmed function for this position is active. To deactivate position #1 functions, move the slide switch all the way to the left (Position #0).

**Position #2** (two detents to the right of the OFF position) - When the slide switch is in this position, the programmed function for this position is active. To deactivate position #2 functions, move the slide switch all the way to the left (Position #0).

**Position #3** (three detents to the right of the OFF position) - When the slide switch is in this position, the programmed function for this position is active. To deactivate position #3 functions, move the slide switch all the way to the left (Position #0).

## Wire Gauge Calculation Chart

		Wire Gauge (AWG)										
		22	20	18	16	14	12	10	8	6	4	2
Current Draw (AMPS)	5	6	9.5	15	24.5	39	62	98	156	248	395	629
	10	3	5	7.5	12	19.5	31	49	78	124	197	314
	15	INS.	3	5	8	13	20.5	32.5	52	82.5	131	209
	20	INS.	INS.	4	6	9.5	15.5	24.5	39	62	98.5	157
	25	INS.	INS.	3	5	8	12.5	19.5	31	49.5	79	125
	30	INS.	INS.	INS.	4	6.5	10.5	16.5	26	41.5	66	104
	35	INS.	INS.	INS.	3.5	5.5	9	14	22.5	35.5	56.5	89.5
	40	INS.	INS.	INS.	3	5	7.5	12.5	19.5	31	49.5	78.5
	45	INS.	INS.	INS.	INS.	4.5	7	11	17.5	27.5	44	69.5
	50	INS.	INS.	INS.	INS.	4	6	10	15.5	25	39.5	63
	55	INS.	INS.	INS.	INS.	3.5	5.5	9	14	22.5	36	57
	60	INS.	INS.	INS.	INS.	3	5	8	13	20.5	33	52.5
	65	INS.	INS.	INS.	INS.	3	5	7.5	12	19	30.5	48.5
	70	INS.	INS.	INS.	INS.	3	4.5	7	11	17.5	28	45
	75	INS.	INS.	INS.	INS.	INS.	4	6.5	10.5	16.5	26.5	42
	80	INS.	INS.	INS.	INS.	INS.	4	6	10	15.5	24.5	39
85	INS.	INS.	INS.	INS.	INS.	3.5	6	9	14.5	23	37	
90	INS.	INS.	INS.	INS.	INS.	3.5	5.5	8.5	14	22	35	
95	INS.	INS.	INS.	INS.	INS.	3.5	5	8	13	21	33	
100	INS.	INS.	INS.	INS.	INS.	3	5	8	12.5	19.5	31.5	

**INS. = Insufficient All Distances Shown Are In Feet**

### To use this chart:

- Determine the amount of current being drawn through the wire. Locate this number in the vertical left-hand column. If the current value is between adjacent values, use the higher number.
- Follow this row until the length of the installed wire is shown. If the exact length is between adjacent values, use the higher number. Follow this column upwards to find the recommended size (gauge) for this wire.

In the example shown below, the size for a wire with an installed length of 36 feet, through which 22 amps of current will be drawn, must be determined.

A row for 22 amps is not shown, so the row for 25 amps will be used. Follow this row to the right. A column for 36 feet is not shown, so the column for 49.5 feet will be used. Following this column to the top will show that the size of this wire must be at least 6 gauge.

# MPC03 Wiring Diagram

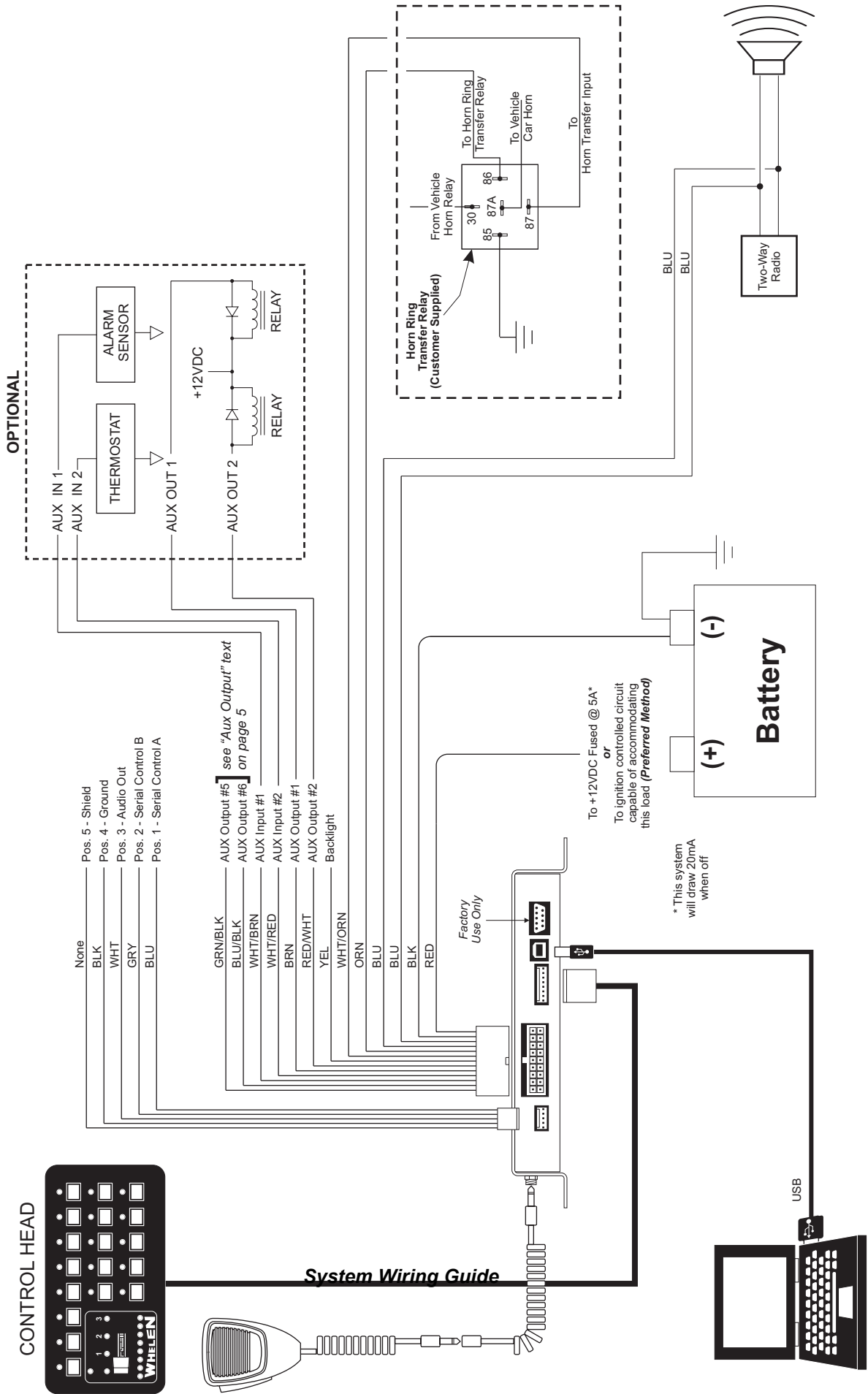



# Diagram for Integrating the MPC03 into an Existing MPC01 System

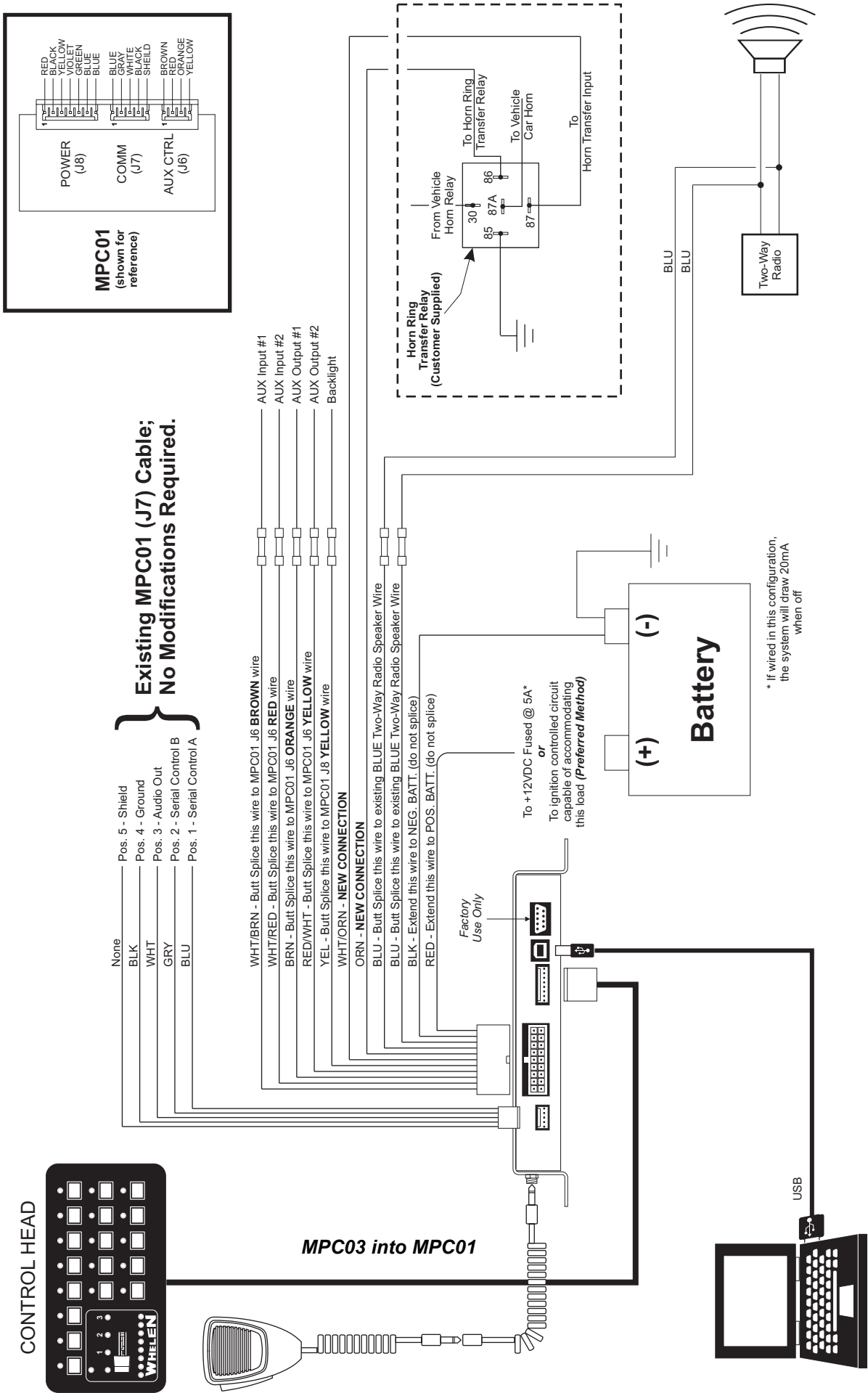

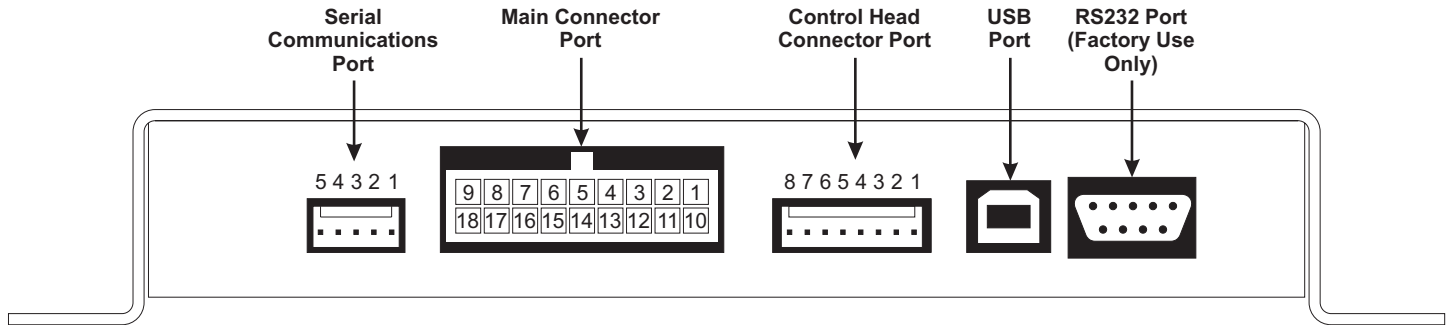

<b>Serial Communications Port</b>	1.	Serial Com. A	BLU
	2.	Serial Com. B	GRY
	3.	Audio Out	WHT
	4.	Ground	BLK
	5.	Shield	None

<b>Main Connector Port</b>	1.	Power (fuse @ 5A)	RED
	2.	Back Light	YEL
	3.	Aux. Output #6	BLU/BLK*
	4.	Aux. Output #5	GRN/BLK*
	5.	Not Used	N/A
	6.	Horn Ring Transfer Relay	ORN
	7.	Aux. Output #2	RED/WHT
	8.	Aux. Output #1	BRN
	9.	Radio Speaker	BLU
	10.	Ground	BLK
	11.	Not Used	N/A
	12.	Aux Input #1	WHT/BRN
	13.	Aux Input #2	WHT/RED
	14.	Horn Transfer Input	WHT/ORN
	15.	Not Used	N/A
	16.	Not Used	N/A
	17.	Not Used	N/A
	18.	Radio Speaker	BLU

<b>Control Head Connector Port</b>	1.	Control Head Connector Cable
	2.	Control Head Connector Cable
	3.	Control Head Connector Cable
	4.	Control Head Connector Cable
	5.	Control Head Connector Cable
	6.	Control Head Connector Cable
	7.	Control Head Connector Cable
	8.	Control Head Connector Cable

*\*Furnished loose. See "Aux Output" section on page 5 for details.*